

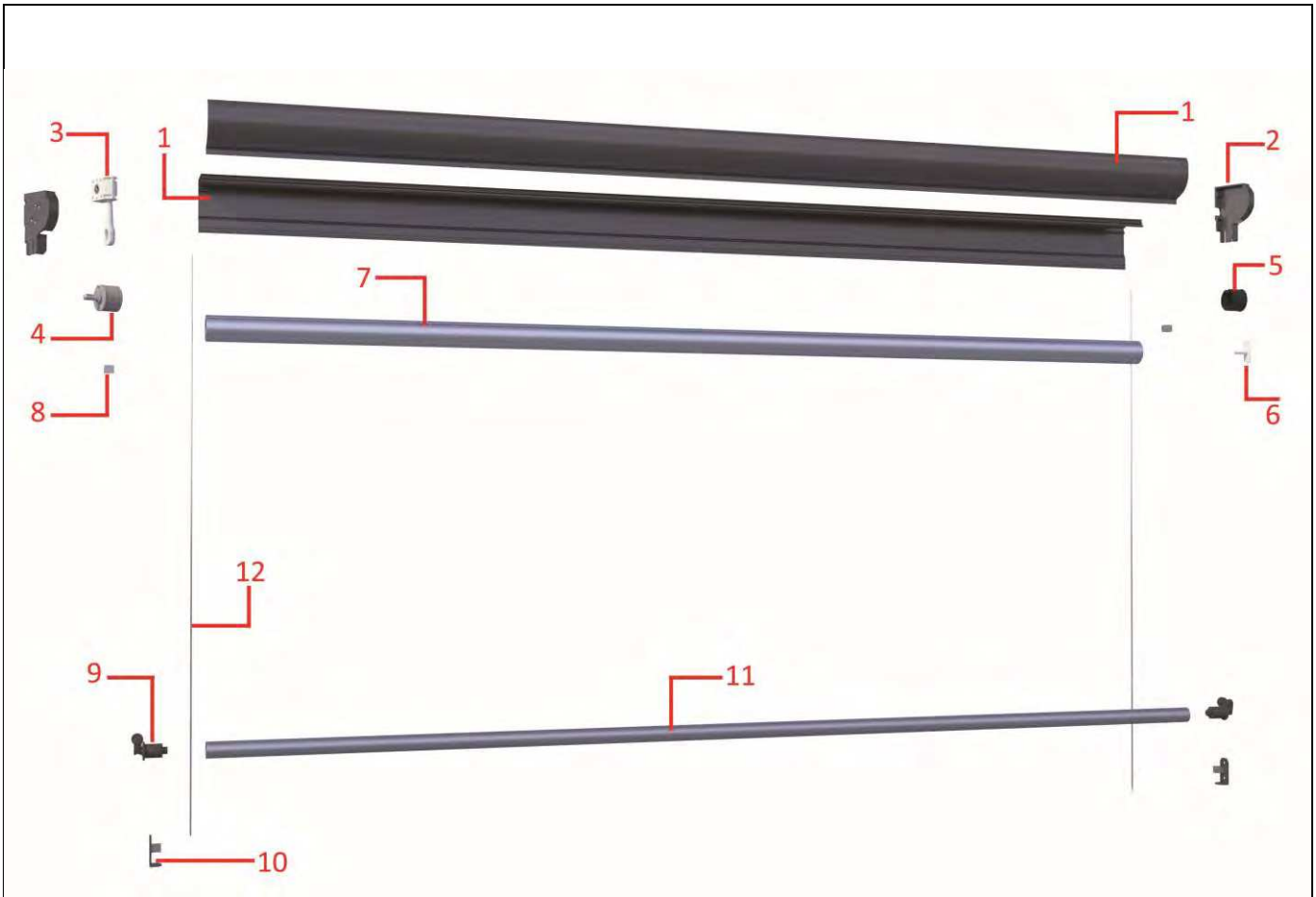

HIGH END BLIND SYSTEM



- Specialized for sun and wind protection, up to 4 Beaufort
- Inox special parts for corrosion resistance
- Aluminium Parts T6-6060 (lightweight)
- Easy installation by two persons, can be installed between walls or on the ceiling
- Durable and long life span
- Functionality on all weather
- Serge Ferrari Soltis Horizon 86 Fabric
- RAL powder coating color finish for all metallic parts
- Minimal aesthetic
- Vertical movement with inox ropes 4mm
- Can be used with electrical motor or by hand mechanism
- Galvanized tube D70mm or D60mm
- Maximum dimensions 236" x 118"





		PRODUCT	CODE	UNITS
1.		WA100 VERTICAL ALUMINIUM CASSETTE MAIN BODY	30.104.0003	157" / 197" / 236"
2.		WA100 SIDE END CAP VERTICAL CASSETTE	30.122.0006	SET

3.		GEAR BOX 1/10-ITALIAN	22.101.0004	PIECE
4.		ROLLER TUBE END CAP WITH SQUARE PIN PVC Φ 70 ITALIAN	22.109.0001	PIECE
5.		ROLLER END CAP FOR BEARING WITH PIN Φ 14 (PVC)	22.109.0009	PIECE
6.		PLATE WITH PIN FOR BEARING Φ 14	30.102.0003	PIECE
7.		Φ 70 GALBANIZE TUBO WITH CANALS	30.105.0095	METER
8.		ROPE HOLDER	30.103.0055	SET

9.		SCREEN CLAMP SANTORINI	22.103.0071	PIECE
10.		BOTTOM RAFTER SUPPORT SANTORINI	30.102.0002	PIECE
11.		METAL GALVANIZED TUBE 1" 1/4	30.105.0005	METER
12.		INOX WIRE ROPE 4 mm	30.103.0004	METER
13.		Motor SOMFY		PIECE

ALUMINUM PROFILE SPECIFICATIONS

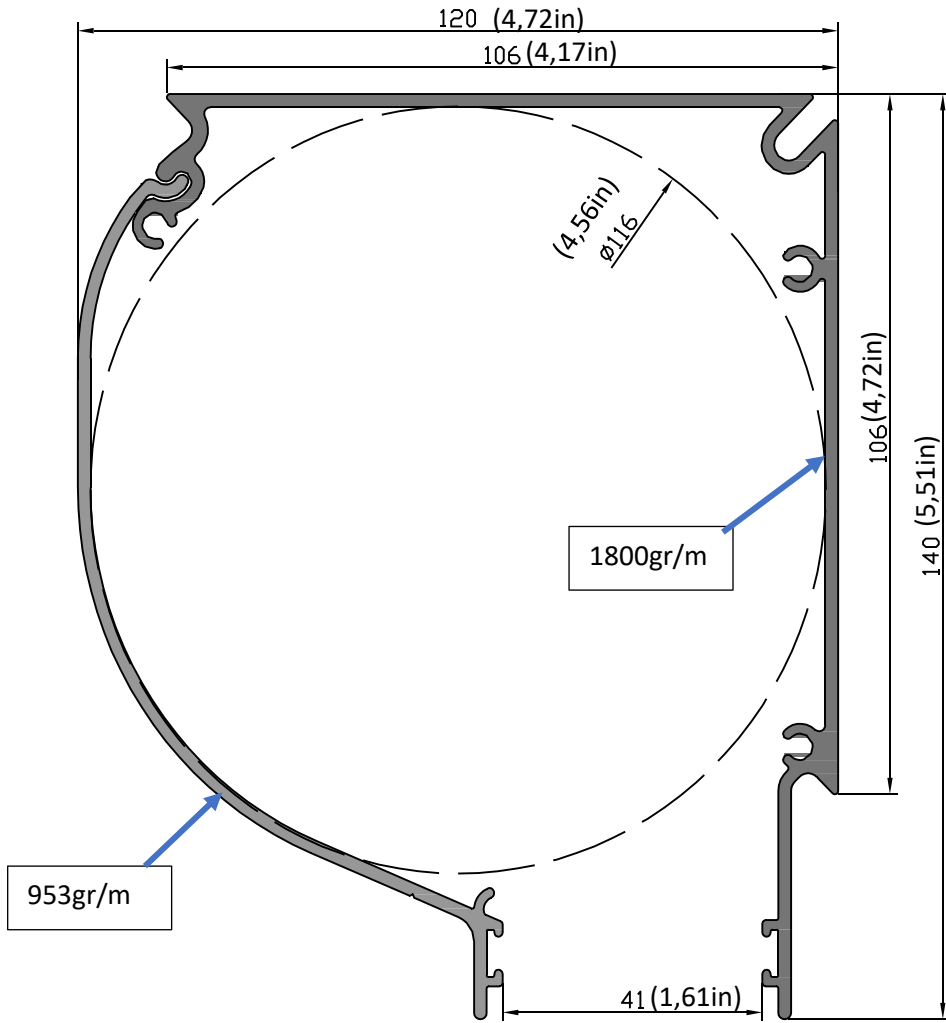

Installation on wall or ceil, with special aluminum part

