

A decorative graphic consisting of a thin red line extending from the top left towards the center, and a dark grey triangle in the top right corner.

# **B CUBE INFINITY**

Technical Information List

V 030818

A solid red horizontal bar at the bottom of the page.







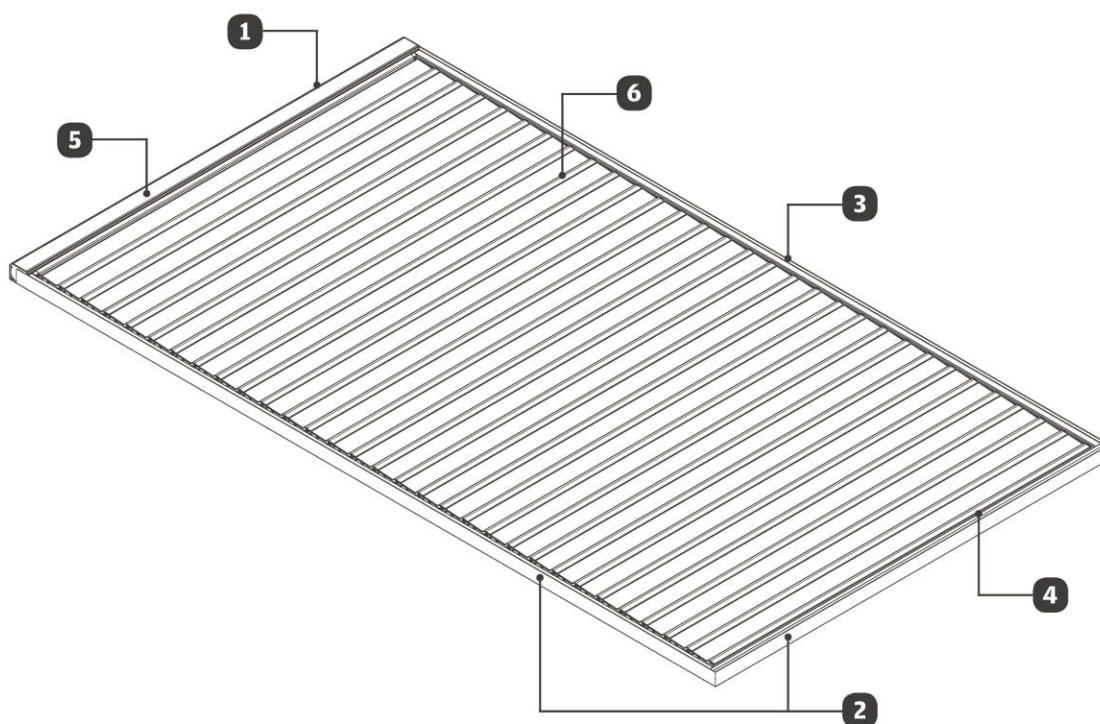

**1** Rear Gutter Profile

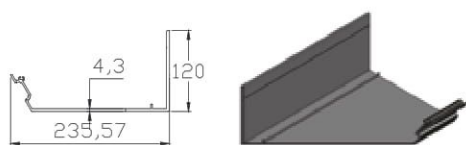

**2** Side and Front Gutter Profile

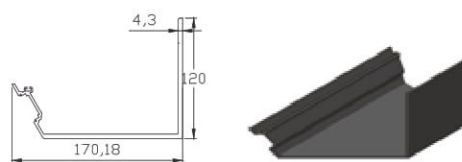

**3** Rafter Profile

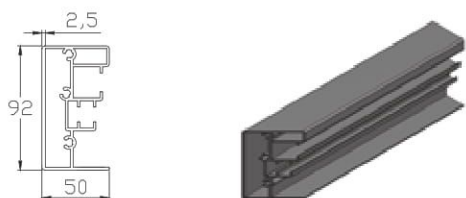

**4** Front Profile

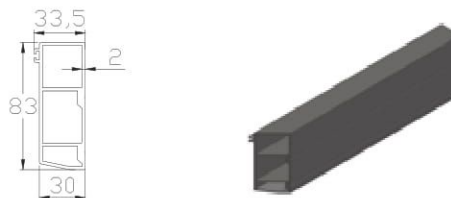

**5** Motor Box Profile

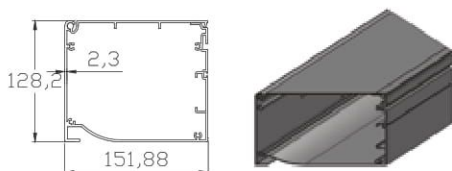

**6** Aerofoil Louvre Profile



\* All dimensions shown above are in milimeters.

# Selection of Optional Items & Accessories

8 WATT  
Integrated & Linear



Lighting  
Dimmer Switch



Integrated Speaker  
Module - Rising Audio  
System



Somfy  
Wind Sensor



Somfy  
Wind and Sun Sensor



Somfy  
Rain Sensor



Rising  
Infrared Heater



Aluminium Powder  
Coating



Aerosol Touch-up  
Spray Paint



Silicone



Packaging with  
Wooden Crate



Ballcony Glass  
& Glazing Systems



Manufacturer of **Shading Systems**  
for Outdoor Spaces



STRING LIGHTS  

---

OUTDOOR