

R4 FALCATE
TECTONA 

Technical Information List

V 240318

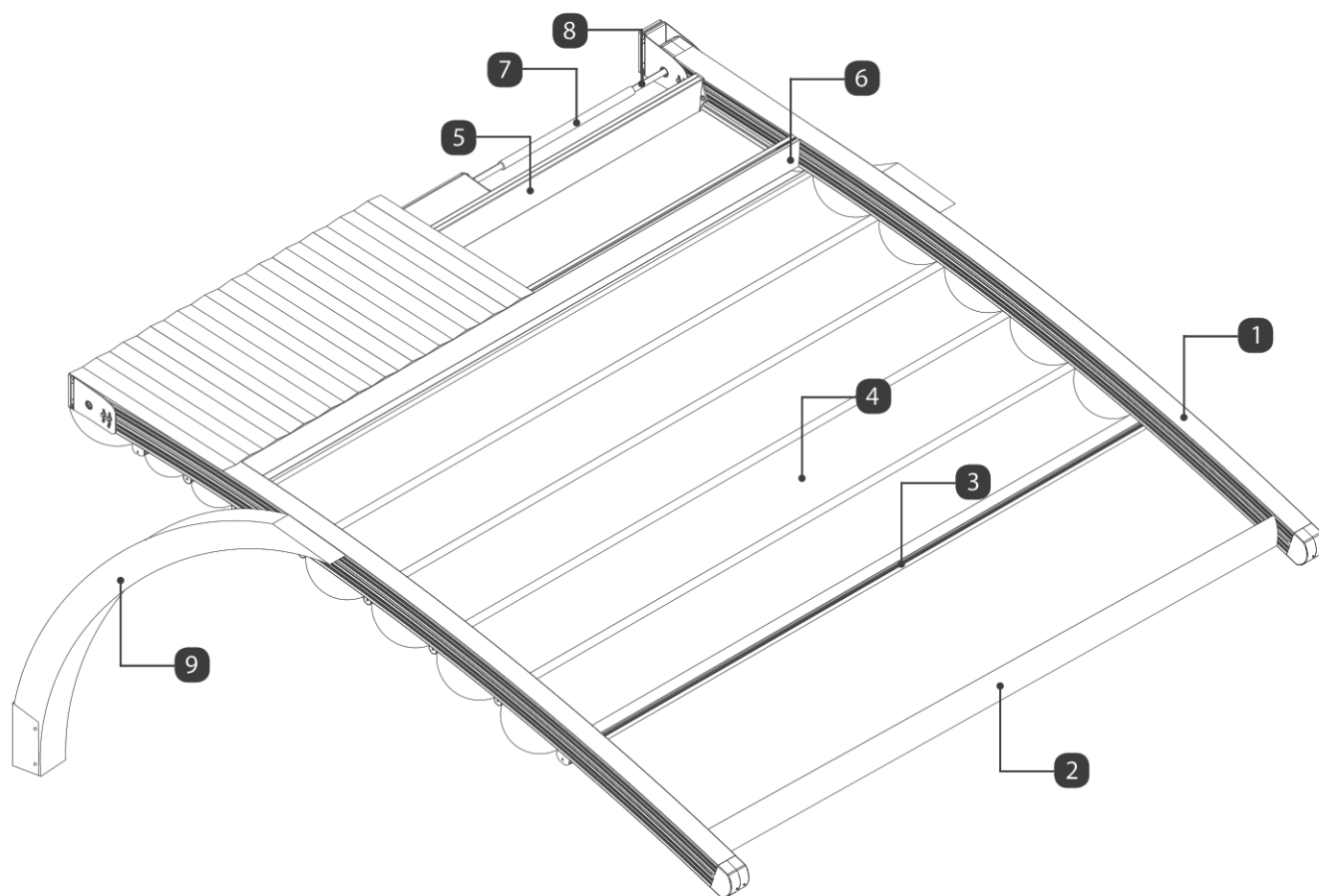



1 Rafter Profile

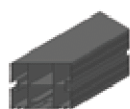
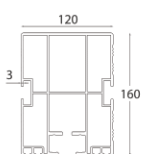

2 Aerofoil Louvre Profile

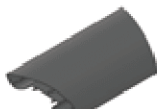
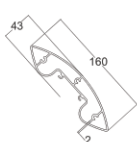

3 Fabric Profile | Master

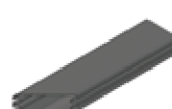
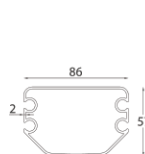

4 Fabric Profile | Carrier

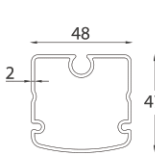

5 Motor Box Profile

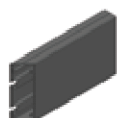
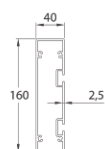

6 Roof Sash Profile

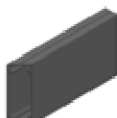
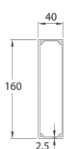

7 Motor Shaft Pipe Profile | Thick



8 Motor Shaft Pipe Profile | Thin



9 Iron Profile 60x60

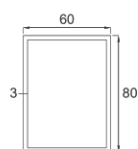

* All dimensions shown above are in millimeters.

Size may vary upon the number of seals

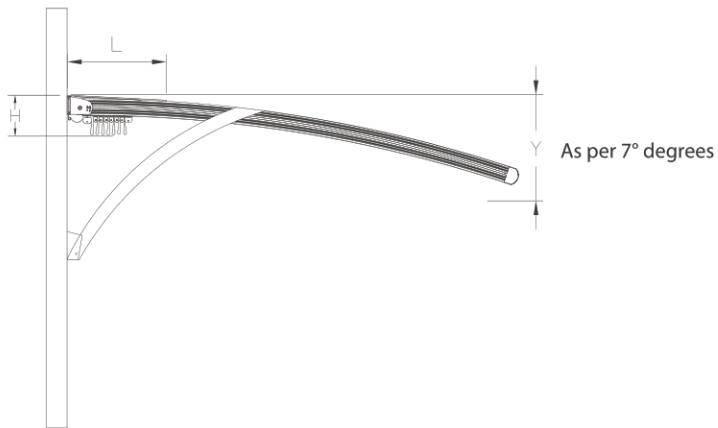

∇ Projection ^	Fabric Fall Height (H)	Hood Cover (L)	7° Degree Rule Fall Height (Y)	Fabric Profile Carrier
3000	562	710	920	7 pcs
4000	580	850	1073	9 pcs

* Distances between fabric profiles had been calculated and measured as 50 cm and it may. Vary upon the measurement of each project therefore you are kindly requested to Contact your key account manager in order to avoid any misunderstanding other wise Rising shading systems will not be responsible for any mistakes that may occur.

Fabric Colour Swatch

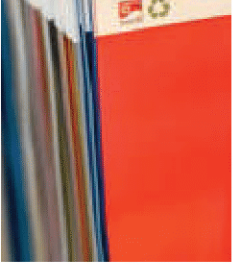

Somfy Wind Sensor



Somfy Wind and Sun Sensor



Somfy Rain Sensor



Rising Infrared Heater



Aluminium Powder Coating



Aerosol Touch-up Spray Paint



Bi-Metal Holesaw



Silicone



Packaging with Wooden Crate



Ballcony Glass & Glazing Systems



Manufacturer of **Shading Systems**
for Outdoor Spaces

Address : Unit C,
Canalside North Business Park,
John Gilbert Way, Trafford Park,
Manchester, M17 1UP
United Kingdom

Phone : +44 (0) 845 400 4677

E-mail : contact@gossoutdoor.co.uk

R4 FALCATE
QUERCUS MINIMA 

Technical Information List

V 240318

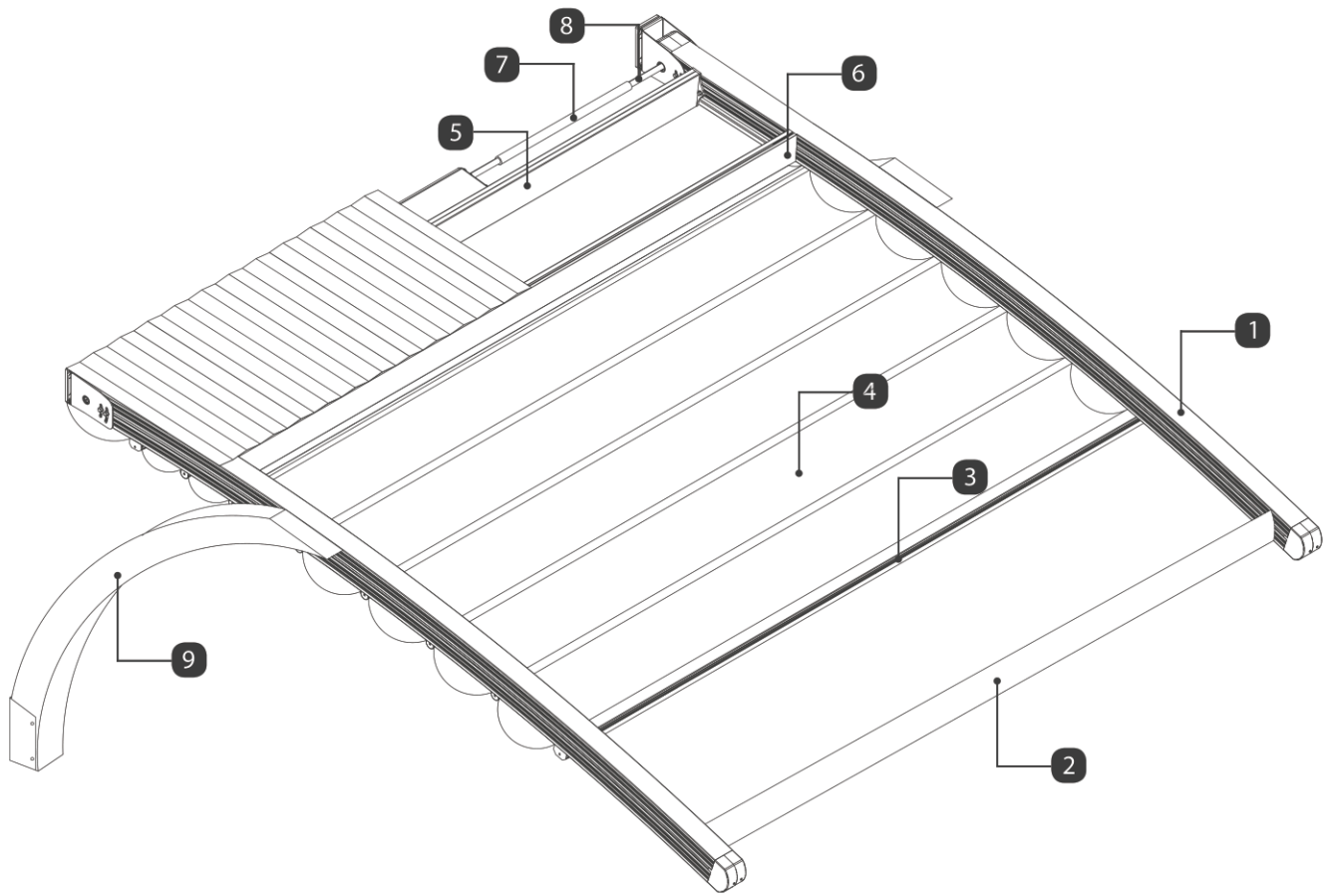

1 Rafter Profile

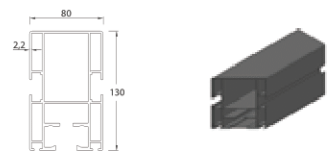

2 Aerofoil Louvre Profile

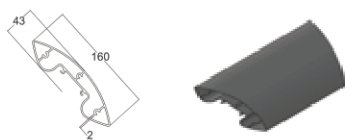

3 Fabric Profile | Master

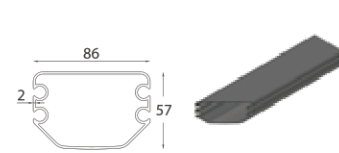

4 Fabric Profile | Carrier

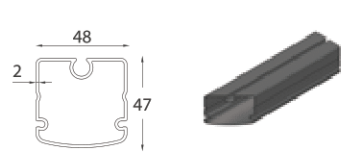

5 Motor Box Profile



6 Roof Sash Profile



7 Motor Shaft Pipe Profile | Thick

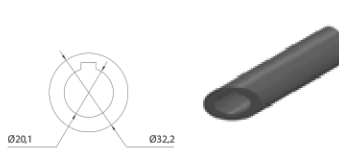

8 Motor Shaft Pipe Profile | Thin

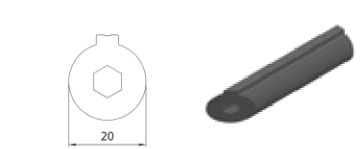

9 Iron Profile 60x60

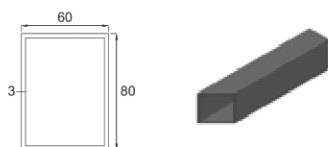

* All dimensions shown above are in millimeters.

Size may vary upon the number of seals

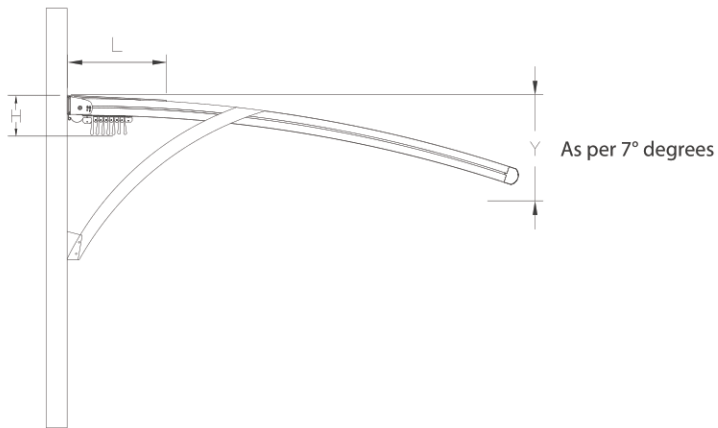

∇ Projection ^	Fabric Fall Height (H)	Hood Cover (L)	7° Degree Rule Fall Height (Y)	Fabric Profile Carrier
3000	508	710	856	7 pcs
4000	516	850	978	9 pcs

* Distances between fabric profiles had been calculated and measured as 50 cm and it may. Vary upon the measurement of each project therefore you are kindly requested to Contact your key account manager in order to avoid any misunderstanding other wise Rising shading systems will not be responsible for any mistakes that may occur.

Possible Module Combinations

Fabric Colour Swatch

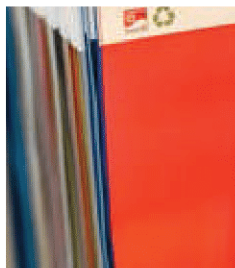

Somfy Wind Sensor



Somfy Wind and Sun Sensor



Somfy Rain Sensor



Rising Infrared Heater



Aluminium Powder Coating



Aerosol Touch-up Spray Paint



Bi-Metal Holesaw



Silicone



Packaging with Wooden Crate



Ballcony Glass & Glazing Systems

Manufacturer of **Shading Systems**
for Outdoor Spaces

Address : Unit C,
Canalside North Business Park,
John Gilbert Way, Trafford Park,
Manchester, M17 1UP
United Kingdom

Phone : +44 (0) 800 400 4549

E-mail : contact@gossoutdoor.co.uk